



SISTEMAS VRF

811 762 8103

www.esen-hvac.com

info@esen-hvac.com



UNIDADES INTERIORES



Muro Alto
.4 – 2.7 R.T.



Piso - Techo
.8 – 4.5 R.T.

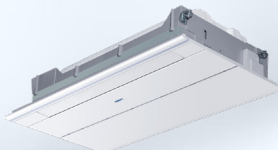

Cassette 1 Vía
.6 – 2.3 R.T.

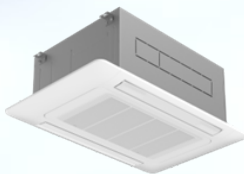

Cassette 2 Vías
.8 – 2.3 R.T.

Cassette Compacto
.4 – 1.6 R.T.

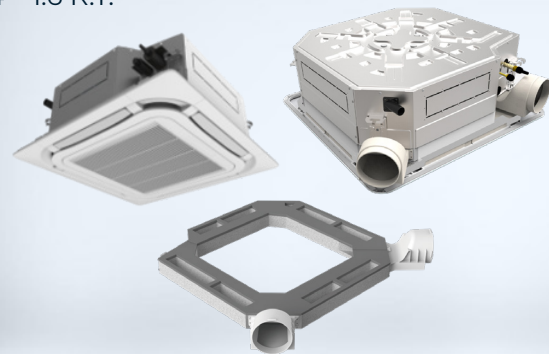

Cassette
.6 – 4.0 R.T.

Fan & Coil

Alta Estática .6 – 5.1 R.T.



Baja Estática

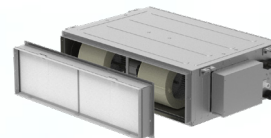

Filtro de Alta Eficiencia
Filtro PM2.5 | Medio
Nivel de Eficiencia (70~95%)

UNIDADES EXTERIORES

**Mini VRF
EGMV 5**



GMVL-80WL/C-T(D) 2.5 R.T.
GMVL-100WL/C-T(D) 3.2 R.T.
GMVL-120WL/C-T(D) 3.5 R.T.



GMVL-140WL/C-T(D) 4.0 R.T.
GMVL-160WL/C-T(D) 4.5 R.T.
GMVL-180WL/C-T(D) 5.1 R.T.

**EGMV 5
Slim**



GMV-224WL/C-F(B) 6.5 R.T.
GMV-280WL/C-F(B) 8.0 R.T.
GMV-335WL/C-F(B) 9.5 R.T.

•Inverter •Side Discharge •Non-Modular •R-410A
•Cooling Only or Heat Pump •208~230V | 1 | 60Hz

•Inverter Side Discharge Non-Modular
Heat Pump 208~230V | 3 | 60Hz R-410A

EGMV 6 Heat Pump Full Inverter 220V | 460V | 3F | 60Hz



Single Fan
8/10/12 HP



Double Fans
14/16/18/20/22/24 HP



Combined Modules
Max 96 HP

GESTIÓN Y CONTROL INTELIGENTE

Sistema de Monitoreo Remoto ESEN

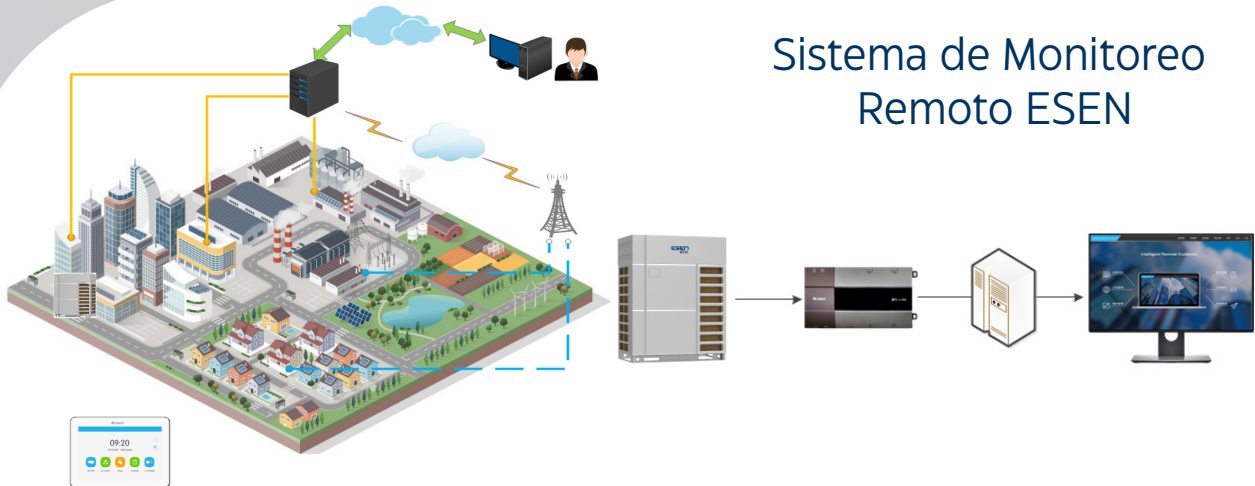

SOLUCIÓN DE CONTROL CENTRALIZADO LOCAL

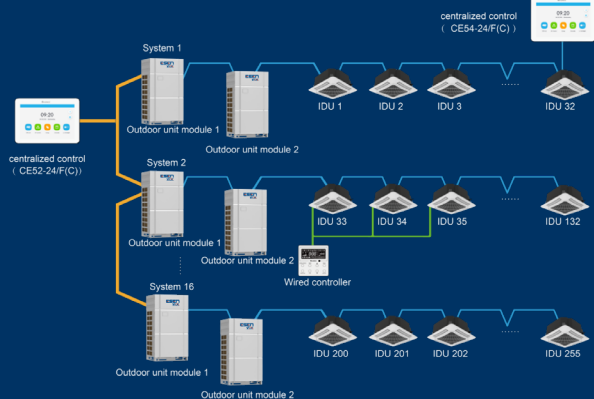

SISTEMA DE FACTURACIÓN INTELIGENTE ESEN

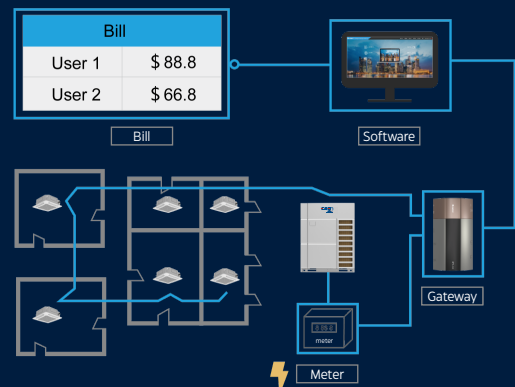

DESEMPEÑO EXCELENTE

✓ Rango De Trabajo Super Amplio

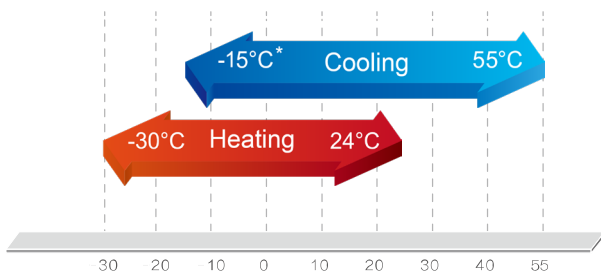

Nota: El enfriamiento a -15°C es condicional. Consulte a nuestros ingenieros para obtener más información. En general, la temperatura de funcionamiento más baja para la refrigeración es de -5°C.

✓ Diseño novedoso de ventilador de gran volumen de aire

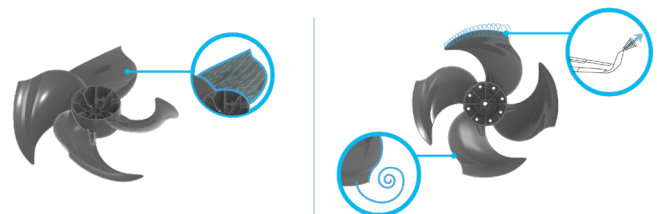

Volumen de Aire  16%